

## LiINE 1300

Flexible lighting module - 320 LED/m - IRC80 - 24V

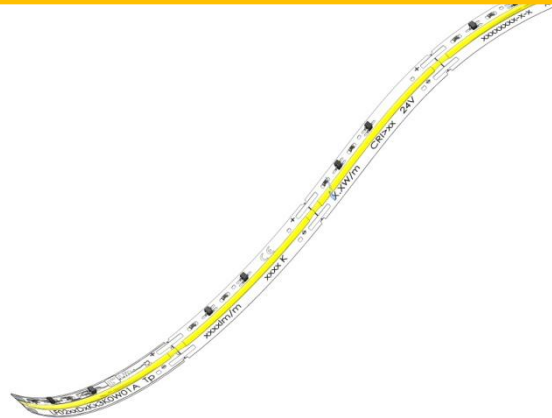

### 1 - KEY FEATURES & BENEFITS

- Linear filament chip-on-flex with self-adhesive back
- Constant Voltage design
- 320 LED/m
- Constant Current LED control
- Maximum length : up to 5m @ 24V
- Can be cut every 5cm
- Luminous efficacy = Up to 140 lm/W
- Small color tolerance MacAdam 3
- Lightweight
- 50000 h lifespan L80B20
- Efficient heat transfer

### 2 - APPLICATIONS

- Decoration
- Linear light

### 3 - PRODUCT AVAILABILITY

Length	Lumens *	CCT
3m	1300lm/m	2700 - 3000 - 4000 - 6500 Other CCT available on request

\* Luminous flux @ 2700K

## 4 - NOMENCLATURE

L	Product class: L = Product catalogue			
F	Product type: F = Flexible module constant voltage			
02	Product family: 02 = Liine			
27	30	40	65	CCT: 27 = 2700K / 30 = 3000K / 40 = 4000K / 65 = 6500K
D	IRC: D = >80			
3K9	Lumens : 3K9 = 3900 (1300lm/m)			
3K0	Length (mm) : 3K0 = 3000			
W	Connection type: W = Without			
01	Product version			
A	Packaging : A = Reel			

## 5 – PHOTOMETRIC SPECIFICATIONS

### Measurement conditions

U(V) : 24V DC

Tp(°C) : 35°C @ambient temp.25°C

### Photometric code

2700K: 827/368

3000K: 830/368

4000K: 840/368

6500K: 865/368

*Indication : tolerance for flux data +/-10%*

CCT (K)	Ra	Lumens/m (lm)*	Lm/W*
2700	>80	1300	130
3000	>80	1310	132
4000	>80	1350	137
6500	>80	1370	140

*\*Theoretical & targeted values - Measurement conditions : length of 1m.*

### Radiation angle (typ)

Angle(°): 120

CCT (K)	CIE 1931 x	CIE 1931 y	SDCM
2700	0.4578	0.4093	3
3000	0.4340	0.4026	3
4000	0.3800	0.3755	3
6500	0.3126	0.3280	3

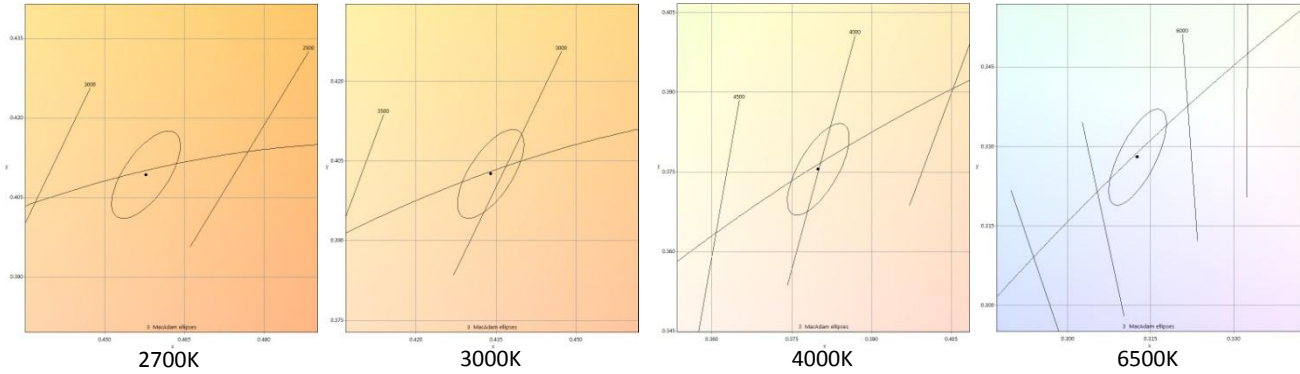

## 6 – LIGHT DISTRIBUTION

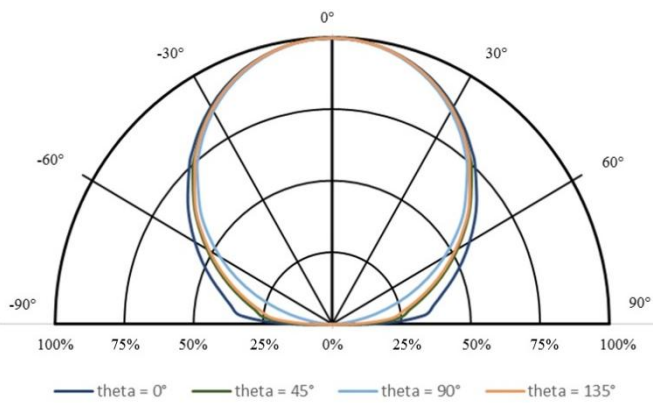

## 7 – MINIMUM & MAXIMUM RATINGS

Parameter	Symbol	Min	Typ	Max	Unit
Forward current	IF	-	415	-	mA
Wattage/m	W	-	9.8	-	W/m
Forward voltage	VF	-	24	-	V/m
Reverse voltage	VR	-	30	-	V/m
Max length @24V*	m	-	-	5	m
Ambiant temperature	AT	-20	25	50	°C
Operating temperature	TOPR	0	35	60	°C
Storage temperature	TSTG	-40	-	80	°C

\*4m@22.8V and 7m@25.2V

## 8 – TUNING INFORMATION

Flux and efficacy versus temperature at Tc (@U nominal)

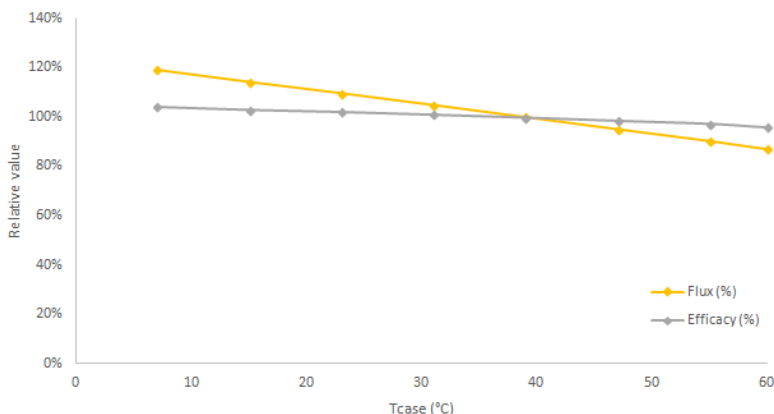

Tc (°C)	Flux (%)	Efficacy (%)
7	119%	104%
15	114%	103%
23	110%	102%
31	105%	101%
39	100%	100%
47	95%	99%
55	90%	97%
60	85%	96%

## 9 – LIFETIME

Parameter	Values	Condition	Unit
Lifetime	50 000	L80 B20	h
Performance temperature	35	@25°C ambient	°C

## 10 – PRODUCT DIMENSIONS

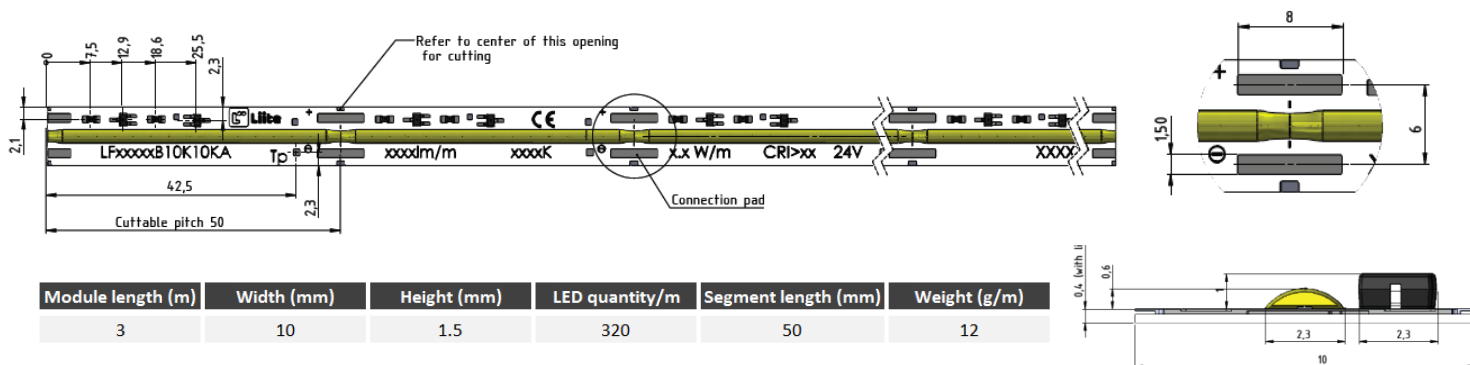

## 11 – THERMAL MANAGEMENT

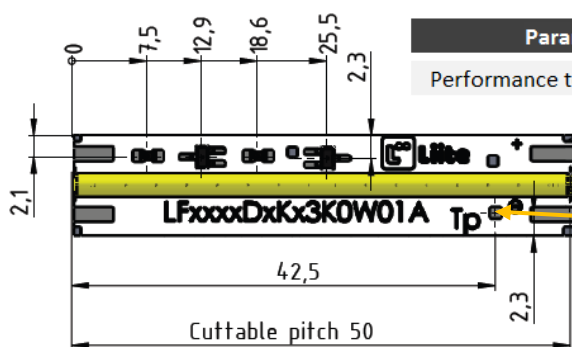

Parameter	Symbol	Min	Typ	Max	Unit
Performance temperature (tp)	Tp	-	35	60	°C

Tp point position (placed every 50mm segment)

## 12 – ENVIRONMENT APPLICATION

IP rating	IP 00
Overheating protection	No protection
Luminaire class	Class III
Dimming	Yes

## 13 – ENVIRONMENT APPLICATION

Item	Compliant to	Result/remark
Safety	Eye safety : EN62471 : 2008	Group 0
Safety	EN 62031 - 2008 + A1 (2013)	Compliant
Performance	IEC 62717 : 2017	Compliant
Hazardous substance & material	ROHS - 2011/65/UE	Compliant
Hazardous substance & material	REACH - 1907/2006/EC	Compliant

## 14 – APPLICATION ADVICES

The products are sensitive to static electricity or surge voltage. ESD can damage a die and its reliability. When handling the products, the following measures against electrostatic discharge are strongly recommended:

- Eliminating the charge
- Grounded wrist strap, ESD footwear, clothes, and floors
- Grounded workstation equipment and tools
- ESD table/shelf mat made of conductive materials

The mounting of the module is facilitated by means of the double-sided adhesive on the back-surface of the module. Care must be taken to provide a clean and dry mounting surface, free of oils or silicone coatings as well as dirt particle. The mounting substrate must have sufficient structural integrity. Take care to completely remove the protective backing.

Care must be taken to not apply pressure on silicone domes when sticking the module to the chosen support. Note that the gluing of the module can only be done once. When partially or entirely glued, the module must not be peel off from its support.

The luminaire manufacturer is responsible for the correct choice and installation of the LED module / LED driver combination according to the application and product datasheets. Proper management of the thermal path should be observed. Adequate heatsinking of strip should be provided in order to maintain performance temperature below maximum.

## 15 – HANDLING

- Liite LED module allows no less than 50mm bending radius in both configurations, LED inside or LED outside.

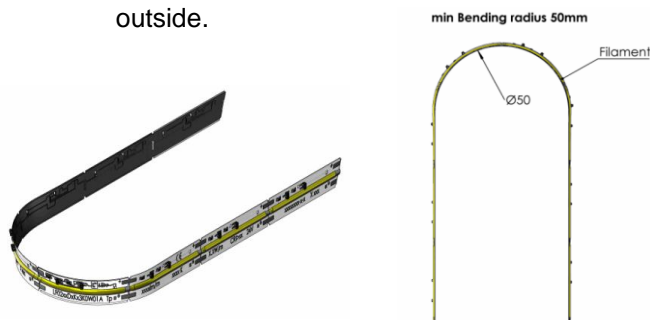

- Don't drop the unit and don't give the unit any shocks.
- Don't store the module in a dusty place or room.
- Don't take the unit to pieces.
- The LED module itself and all its components must not be mechanically stressed.

LED module must be fitted on a heat dissipating surface in order to ensure performances, reliability and lumen maintenance. Avoid insulating air gaps between adhesive part and mounting surface.

Components handling, placement, soldering, and generally all component manipulation should be done according to manufacturer's specifications.

## 16 – SAFETY GUIDELINES

Read the following instructions before installation.

Disconnect power before connecting or disconnecting the module and verify that the voltage on the module's data sheet matches your electrical installation. If this is not the case, contact your dealer and do not connect the module.

Installation and any work on the unit must be performed by a qualified professional.

For all interventions, it is imperative that the unit is disconnected from main power and cool before handling.

If over voltage which exceeds the absolute maximum rating is applied to the module, it will cause irreversible damage to circuits (LED included) and result in malfunction or non-function of the product.

Never immerse the device in water or other liquid.

Do not put conductive objects or fingers in contact with the unit in operation to prevent damage and avoid electrical short-circuit.

Do not look directly into lighted module. Use proper eye equipment to look straight at it.

**THE MANUFACTURER SHALL NOT BE LIABLE FOR MISUSE OF DEVICE. KEEP THESE INSTRUCTIONS CAREFULLY**

## 17 – RECYCLING

At the end of their lifetime, we recommend that the LIITE LED Liine modules and its components are disposed of in an appropriate way. The modules are pieces of electronic equipment containing components that are currently considered to be harmful to the environment. We therefore recommend not to throw away in the dustbin and that these parts are disposed of as normal electronic waste, in accordance with local regulations.



## 18 – PACKAGING

Reel of 3m

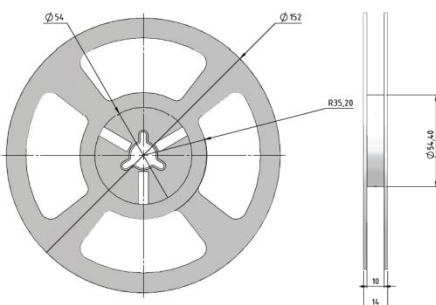

Inner box : 10 reels of 3m

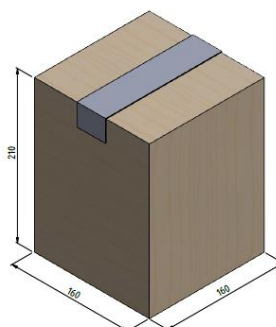

Outer box : 8 inner boxes

